

i

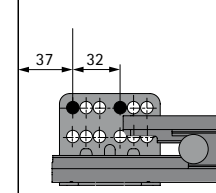

NL	b1				
		X	Y	X	Y
mm	mm	mm	mm	mm	mm
270	128	217	285	235	303
300	160	247	315	265	333
350	192	297	365	315	383
400	192	347	415	365	433
450	192	397	465	415	483
500	224	447	515	465	533
550	256	497	565	515	583
650	288	597	665	615	683

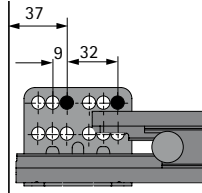
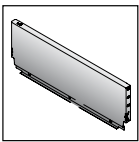
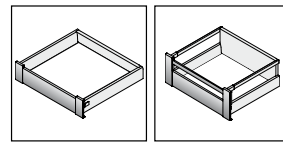
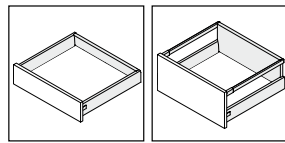
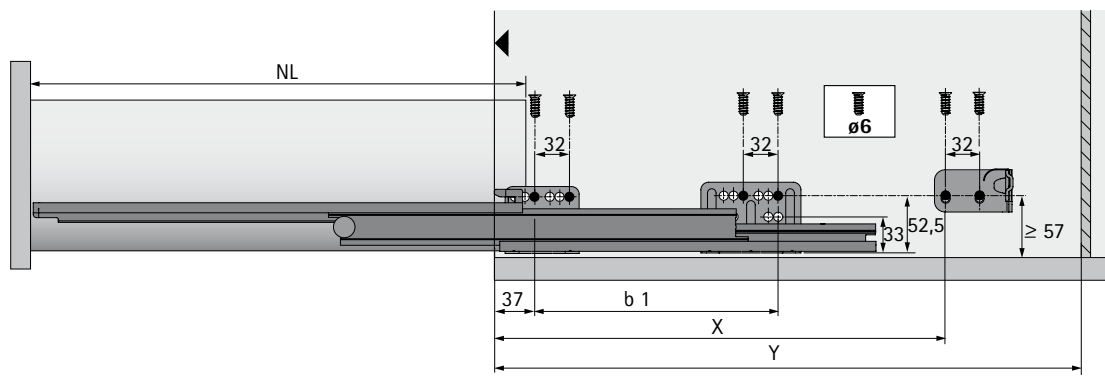
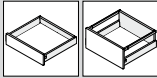
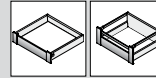
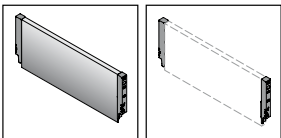
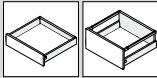
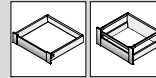

NL	b1				
		X	Y	X	Y
mm	mm	mm	mm	mm	mm
270	128	228	296	246	314
300	160	258	326	276	344
350	192	308	376	326	394
400	192	358	426	376	444
450	192	408	476	426	494
500	224	458	526	476	544
550	256	508	576	526	594
650	288	608	676	626	694