













INSTALLATION INSTRUCTION



Name	Type	Q'ty	Name	Type	Q'ty	Name	Type	Q'ty
A Bottom Runner		1 pcs	E T-bar		2 pcs	I Adjusted screw M8X25		2 pcs
B Upper Slide		1 pcs	F Basket		5 pcs	J Fixed screw M6X20		2 pcs
C Frame		1 pcs	G Back clip		14 pcs	K Fixed screw M6X12		1 pcs
D Door Frame		1 pcs	H Allen Key		1 pcs	L Fixed screw M6X20		1 pcs

STEP 1 : Screw bottom runner on bottom panel .

STEP 2 : Screw top slide on top panel .

STEP 3 : Screw T-bar and Door frame on door panel .

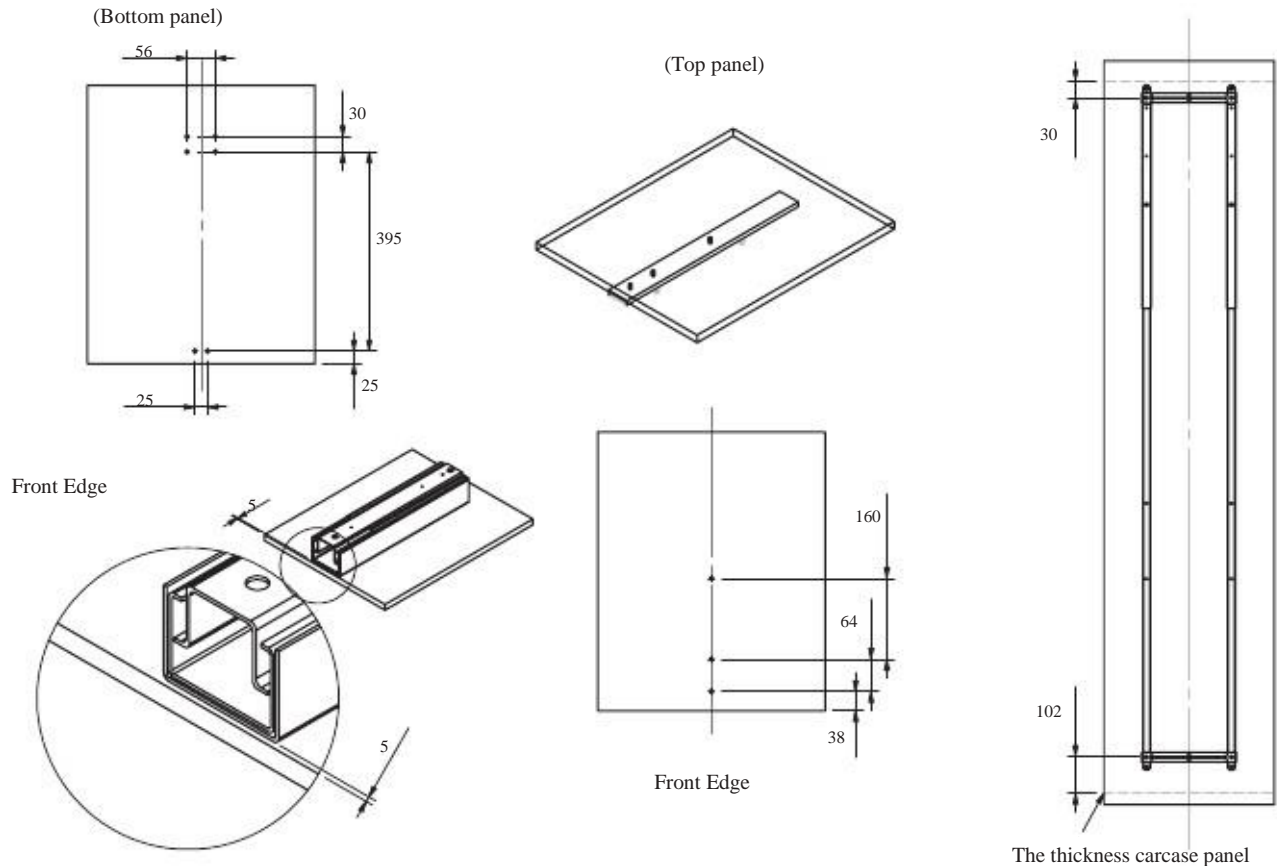

INSTALLATION INSTRUCTION

Step 4 : Frame to be screwed on Runner
Step 5 : To adjust the pro-mounted unit in the cabinet.(K,L,I)

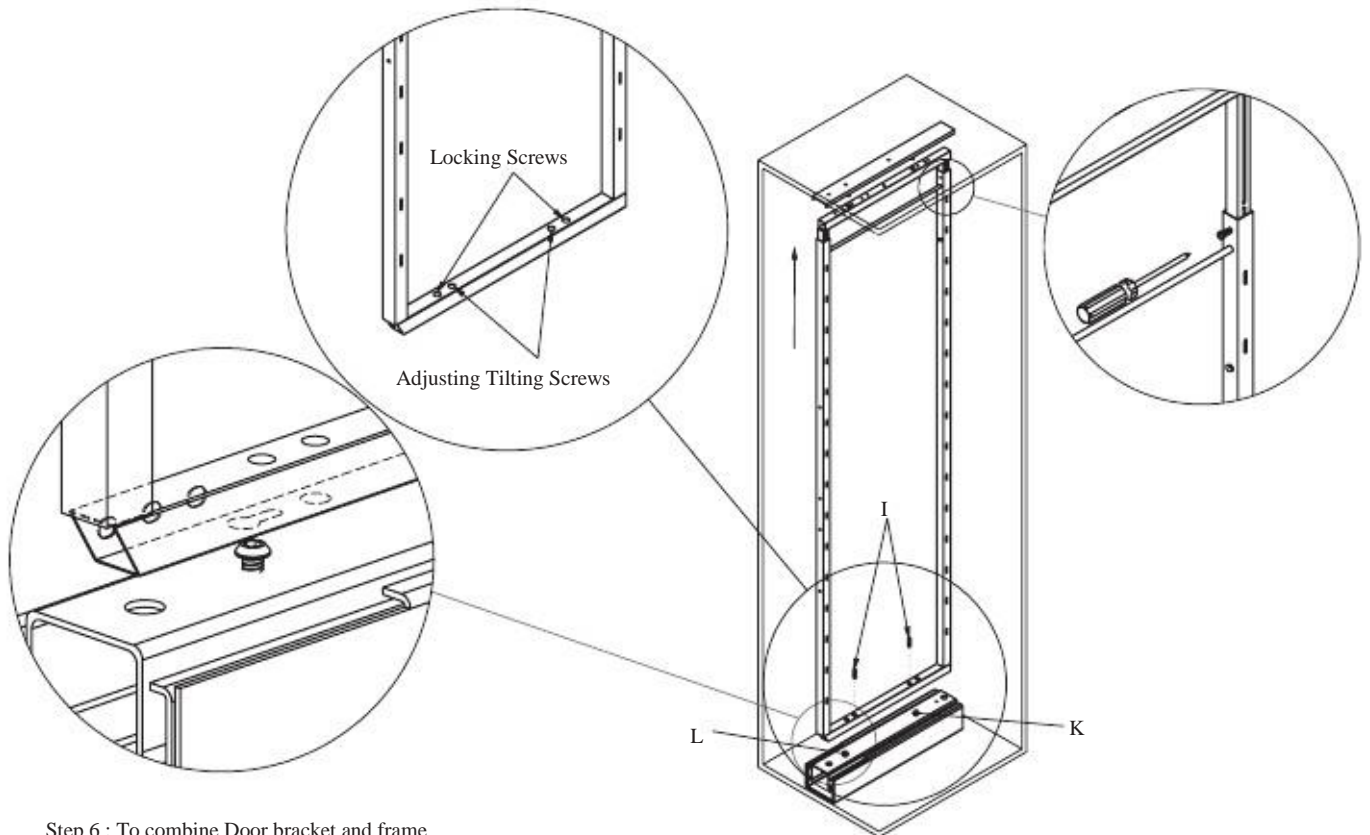

Step 6 : To combine Door bracket and frame
Step 7 : To adjust Door bracket screw
Step 8 : To insert the hanging plates
Step 9 : Hanging Clip-on Baskets on the plates

